

# JTS®

## TG-10STX/TG-10SRX

Stationary Transmitter/Stationary Receiver

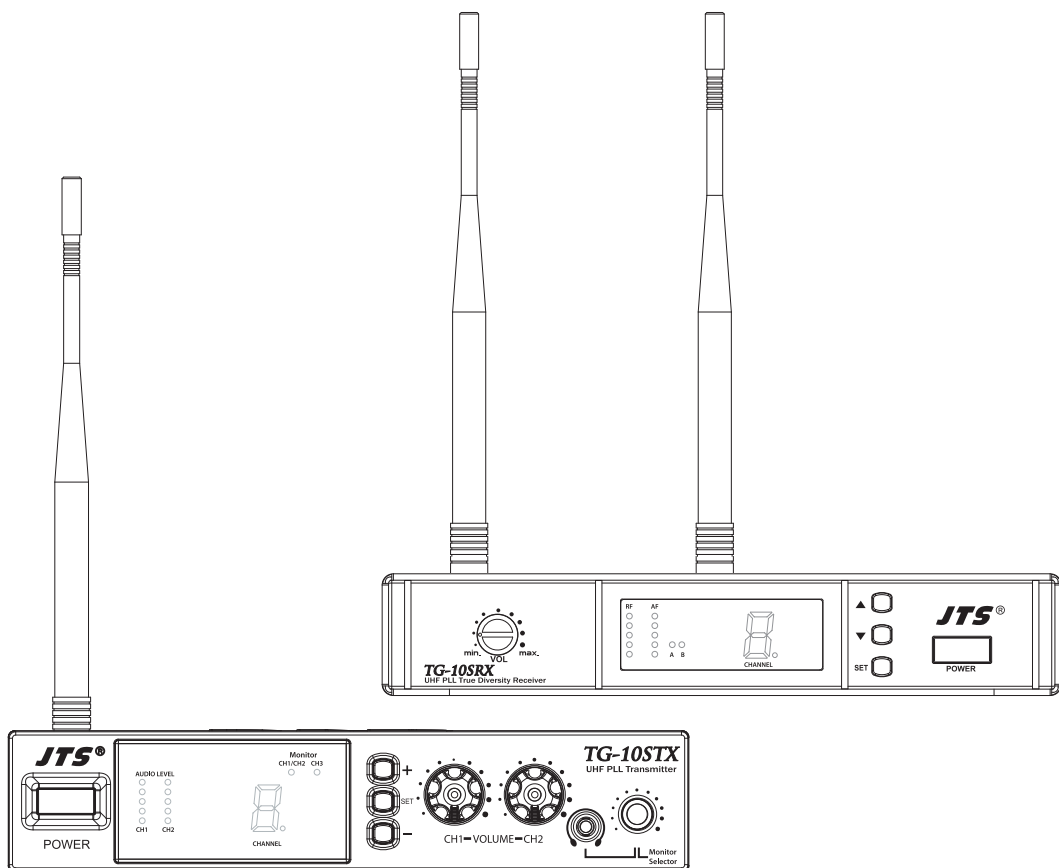

# TABLE CONTENTS

## **TG-10STX Stationary Transmitter**

1. Important Cautions .....	1
2. Introduction.....	1
3. Specification .....	1
4. Parts Identification & Accessories .....	2
5. Preparing procedures & basic operation .....	3
6. Loop Out Application .....	5

## **TG-10SRX Stationary Receiver**

1. Important Cautions .....	6
2. Features .....	6
3. Specification .....	7
4. Parts Identification & Accessories .....	7
5. Preparing procedures & basic operation .....	8
6. Recommendation.....	9

Thank you for choosing JTS wireless system. In order to obtain the best efficiency from the system, you are recommended to take few minutes to read this instruction manual carefully.

# TG-10STX Stationary Transmitter

## 1. Important Cautions

- Make all connections before plugging the unit into an AC power outlet.
- Do not leave the devices in a place with high temperature or high humidity.
- Do not handle the power cord with wet hands.
- Keep the devices away from fire and heat sources.

## 2. Introduction

The TG-10STX is an UHF PLL stationary transmitter with 16 selectable channels. It works with all JTS 16 channel systems with channel indication 0,1,2.....9,A,B.....F.

Together with directional antenna UDA-49P, antenna booster UB-900 the TG-10STX can provide stronger signal for larger coverage.

## 3. Specification

Carrier Frequency Range.....	502~960MHz
RF Output Power.....	Hi / Low
Nominal Frequency Deviation (modulation)	$\pm 40\text{KHz}$
Audio Input Impedance.....	20K $\Omega$
Nominal Input Level.....	-20 dBV
Maximal Input Level.....	0 dBV
LED Display.....	AF Level, Channel
Audio Input Connector.....	2 x Balanced XLR / $\varnothing 6.3\text{mm}$ Combo input $\varnothing 6.3\text{mm}$ monitor input
Output Monitor Connector.....	1 x $\varnothing 3.5\text{mm}$ phone Socket
Loop Out Connector.....	2 x $\varnothing 6.3\text{mm}$ Balanced Loop Out Socket
Operation Voltage.....	12-18 VDC, 600 mA
Dimension(m/m).....	210mm (W)* 44mm (H)* 239mm (D)
Channel.....	16 selectable channels

## 4. Parts Identification & Accessories

1. Power On/Off switch
2. LED Display
3. Channel Selector ( + button )
4. Set button
5. Channel Selector ( - button )
6. Volume control
7. Monitor volume control
8. 1/8" Stereo Phone Jack
9. Antenna
10. DC input ( 12~18V 600mA )
11. Balanced Loop Out Connector CH.1
12. Balanced Loop Out Connector CH.2
13. Balanced XLR/Ø6.3mm Combo Input Left / CH.1
14. Balanced XLR/Ø6.3mm Combo Input Right / CH.2
15. BNC Antenna Output Socket
16. Monitor input (mono Ø6.3mm phone jack)
17. Input CH1 phantom power switch

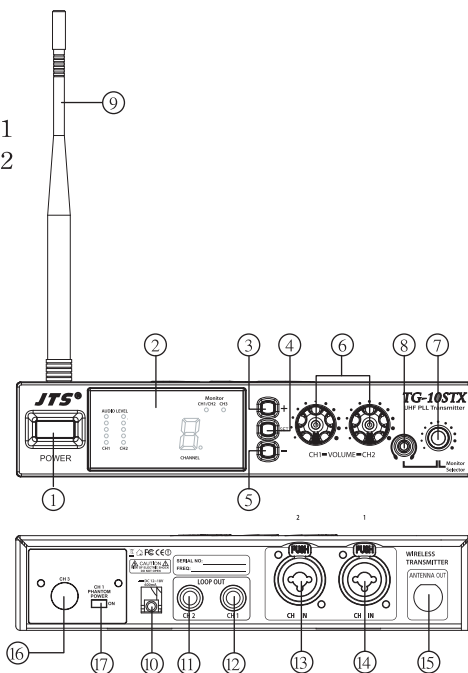

### Optional Accessory

18. RM-901 Rack Mount Kit
19. RTF-1 Antenna Extension Cable

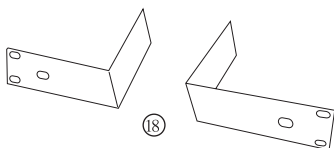

## 5. Preparing procedures & basic operation

(1.) Connect the main unit

Connect the DC INPUT in the rear panel of TG-10STX to an AC to DC adaptor.

(2.) Basic operation

1. Connect the mixer output to the XLR / Ø6.3mm combo CH1 input at the rear panel of TG-10STX with AF input cable.
2. Connect the gooseneck mic and gooseneck mic base at the XLR / Ø6.3mm combo CH2 input at the rear panel of TG-10STX with AF input cable.
3. Connect the TG-10SRX or CS-1CU at the Ø6.3mm mono CH3 input at the rear panel of TG-10STX with AF cable as a source for interpretation.

NOTE:

① Two balanced XLR / Ø6.3mm combo inputs are provided. You may use either one input or both for a stereo source. Also, two balanced Ø6.3mm loop out connectors are provided for multiple systems application.

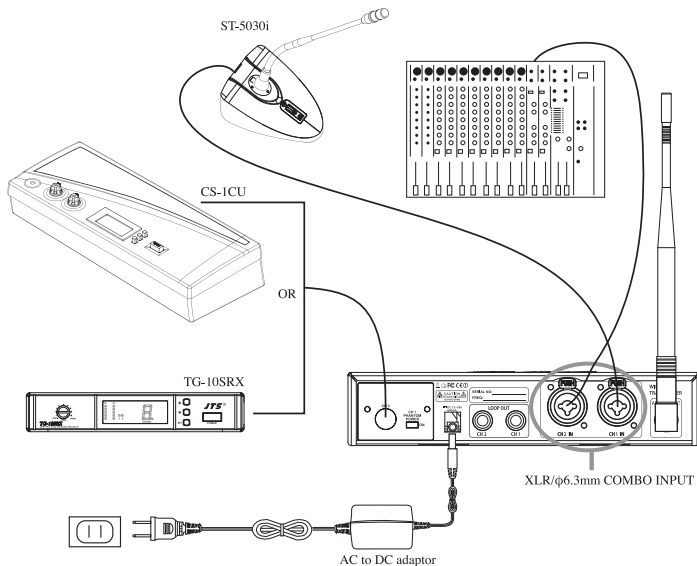

NOTE:

② CH3 is an input signal only for monitoring through monitor headphone and will not be transmitted.

(3.) LCD Display

- ① AF Level of CH1
- ② AF Level of CH2
- ③ Monitor channel display
- ④ Channel display

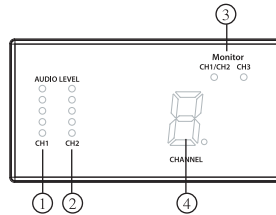

(4.) Attach the antenna

The user-friendly antenna comes with BNC connector. Connect the antenna on the rear of the transmitter and align it upward.



(5.) Power On / Off

Turn on or turn off the transmitter by pressing the “POWER” button.

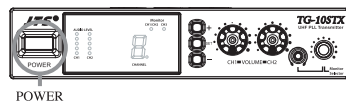

(6.) Volume

Adjust the volume to a proper level.



(7.) Monitor Volume

Adjust the monitor volume to a proper level.

Note that by pushing Monitor Volume user can choose CH1 / CH2 or CH3 to listen.

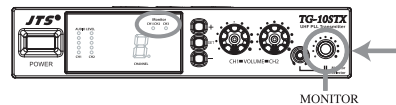

(8.) Select channel

- 1. Press “set” button for about 3 second and then “.” starts flashing on the panel.
- 2. Press “+” or “-” button to increase or decrease the channel number.
- 3. Press “set” button again to store the channel.

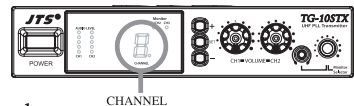

(9.) Set the rubber pad

Four self-adhesive rubber pads are provided to ensure the stability. They are to be placed on the bottom of the transmitter.

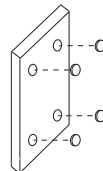

(10.) RTF-1 Antenna Extension Cable (Optional)

Antenna extension cable enables front mounting antenna which benefits the RF efficiency.

### (11.) RM-901 Rack Mount Kit (Optional)

Rack mount kit is available to install the half rack transmitter into a standard EIA rack.

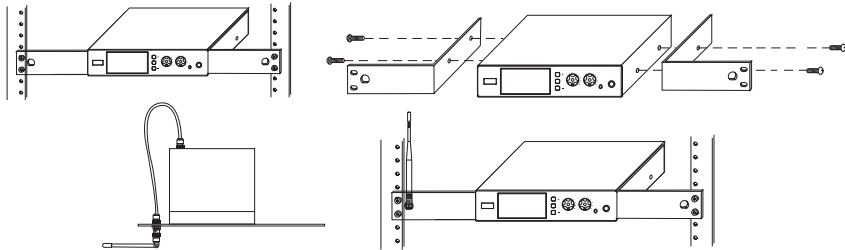

## 6. Loop Out Application

### Multiple Systems

Make use of the loop out connectors to deliver one signal from the mixer to multiple TG-10STX or other devices.

1. Connect the mixer outputs to inputs of the first transmitter.
2. Connect loop out connectors of the first transmitter to the second one.
3. Connect subsequent systems in the same way.

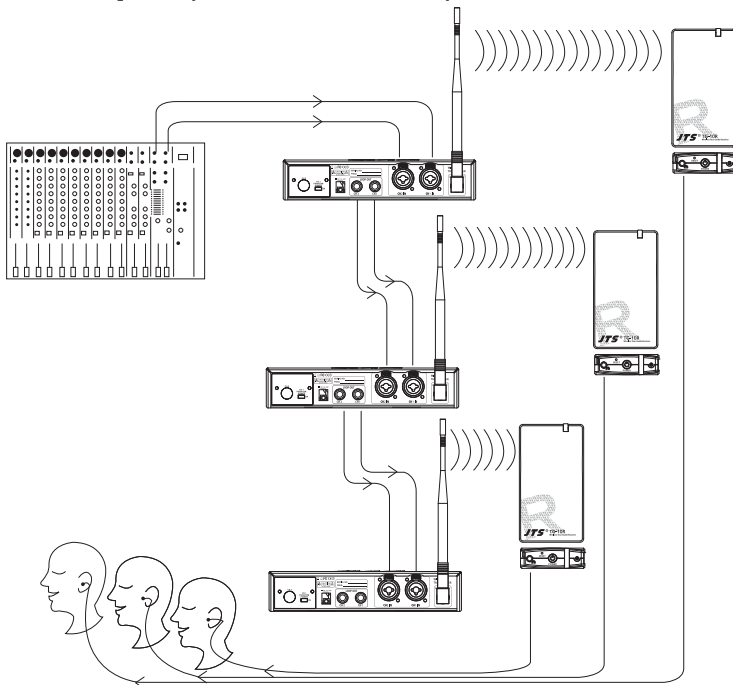

# TG-10SRX Stationary Receiver

## 1. Important Cautions

- Always make all connections before plugging the unit into an AC power outlet.
- Do not leave the devices in a place with high temperature nor high humidity.
- Always do not handle the power cord with wet hands !
- Keep the devices away from fire and heat sources.

## 2. Features

- \* Operated in UHF band where there is less RF interference than the VHF band.
- \* Due to the PLL synthesized technology, the system can offer up to 16 selectable frequencies for choosing simultaneously.
- \* The true diversity reception with 2 independent RF receivers ensure the stable transmission and reception.
- \* Adjustable Pilot tone squelch control can effectively reduce the noise.
- \* Equipped with S.A.W. filter benefits the interference-resistant.
- \* Tuned antennas can benefit the stable RF reception.
- \* Built-in Noise Squelch circuitry & Mute function are available to restrain the interference for signals.
- \* Compact half-rack receiver design is considerable for the space saving.
- \* Rugged metal housing can pass through the difficult environment.
- \* Equipped with balanced XLR and unbalanced output allow great convenience.
- \* Anti-interference design is available to work with every computer device.



### 3. Specification

Frequency Preparation.....	PLL Synthesized Control
Carrier Frequency Range	502~960MHz
S/N Ratio.....	> 105dB
T.H.D.....	<0.6% @1KHz
Display.....	LED
Display Contents.....	AF Level, Channel
Controls.....	Power On/Off, Channel, Audio Level
Audio Output Level.....	-12dB
AF Output Impedance.....	600Ω
Squelch.....	Pilot Tone & Noise Mute
Operation Voltage.....	12-18 VDC, 600 mA
Output Connector.....	1 XLR Balanced Socket 1 Ø6.3mm unbalanced phone jack
Dimension(m/m).....	211mm (W)* 40mm (H)* 125mm (D)
Channel.....	16 selectable channels

### 4. Parts Identification & Accessories

1. Power On/Off switch
2. Channel Selector ( Up button )
3. Down button
4. Channel Selector ( Down button )
5. LED Display
6. Volume control
7. DC socket for connection of main unit
8. AF output, Ø6.3mm phone jack socket (AF UNBAL)
9. AF output, XLR socket (AF BAL)
10. Antenna input socket
11. Antenna

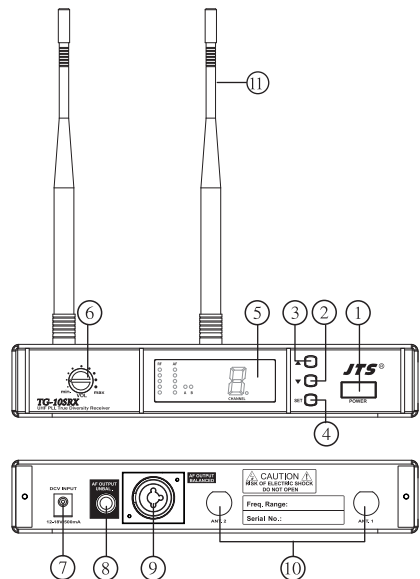

#### Optional Accessories

12. DR-900 Dual Rack Adaptor
13. RP-900 Panel Cover
14. GC-80/GC-100 Guitar Cable
15. GC-80L/GC-100L Guitar Cable

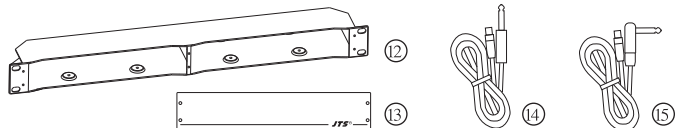

## 5. Preparing procedures & basic operation

### (1.) Power output connector

Plug in one end of AC/DC adaptor cable to DC input socket in the rear panel of receiver, and plug another end into an AC outlet.(Step 1)

### (2.) Audio output connector

Connect one end of the AF output cable to the AF output socket in the rear panel, then plug another end to the “MIC IN” input socket of a mixer or amplifier.(Step 2)

TG-10SRX equipped with balanced XLR output and unbalanced  $\varnothing 6.3\text{mm}$  output, choose the proper way for use.

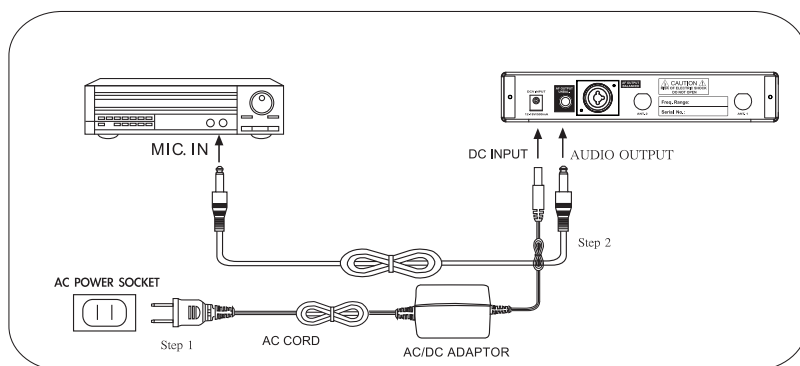

### (3.) LED panel

1. AF signal
2. RF signal
3. Channel Display
4. Diversity Display (A or B antenna)

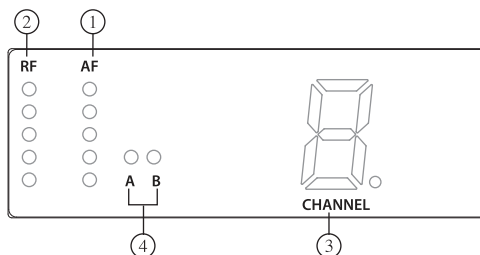

### (4.) Setting the rubber pad

Four self-adhesive rubber pads are provided to ensure the stability.

They are to be placed on the bottom of the receiver.

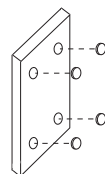

(5.) Connecting the antenna

The user-friendly TG-10SRX antenna comes with easy mount on socket for effortless. Connect two antennas on the back of the receiver and align them upward.

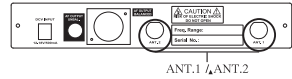

(6.) Turning the receiver on/off

Turn the receiver on by pressing the “POWER” button.

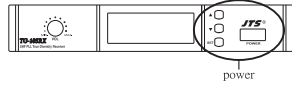

(7.) Adjusting the AF output level

Use the AF output level control located on the front side of the receiver to adjust the AF signal level that appears at output.



(8.) DR-900 dual pack adaptor

The dual rack adaptor is available to unify the half rack space into a standard EIA size with single or dual units.

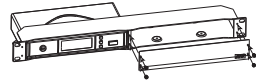

(9.) Basic operation

1. Turning the receiver on and off by pressing the POWER button.
2. Press the SET button for 3 seconds to select frequency and scan.
3. Press the SET button again to store once you make any changes.
4. Press the UP or DOWN button to adjust the setting of a menu.

## 6. Recommendation

1. In order to achieve the optimum reception condition and also extend the operating distance, please leave on “open space” between the receiver and transmitter.
2. Keep the devices away from the metal objects or any interference sources, at least 50 cm.
3. To avoid the feed-back effect, don't leave the mic. to aim at the speakers directly.
4. For best pick-up pattern, please hold the middle of the mic. body.

**JTS**®  
**JTS** PROFESSIONAL CO., LTD.